

A System to convert Gravitational Energy directly into Electrical Energy

Fran De Aquino

Maranhao State University, Physics Department, S.Luis/MA, Brazil.

Copyright © 2012 by Fran De Aquino. All Rights Reserved.

We show that it is possible to produce *strong gravitational accelerations on the free electrons of a conductor* in order to obtain electrical current. This allows the conversion of gravitational energy directly into electrical energy. Here, we propose a system that can produce several tens of kWh of electrical energy converted from the gravitational energy.

Key words: Modified theories of gravity, Electric fields effects on material flows, Electron tubes, Electrical instruments.
PACS: 04.50.Kd, 83.60.Np, 84.47.+w, 07.50.-e.

1. Introduction

In a previous paper [1], we have proposed a system to convert gravitational energy into rotational kinetic energy (*Gravitational Motor*), which can be converted into electrical energy by means of a conventional electrical generator. Now, we propose a novel system to convert gravitational energy *directly* into electrical energy.

It is known that, in some materials, called *conductors*, the free electrons are so loosely held by the atom and so close to the neighboring atoms that they tend to drift randomly from one atom to its neighboring atoms. This means that the electrons move in all directions by the same amount. However, if some outside force acts upon the free electrons their movement becomes not random, and they move from atom to atom at the same direction of the applied force. This flow of electrons (their electric charge) through the conductor produces the *electrical current*, which is defined as a flow of electric charge through a medium [2]. This charge is typically carried by moving electrons in a conductor, but it can also be carried by ions in an electrolyte, or by both ions and electrons in a plasma [3].

Thus, the electrical current arises in a conductor when an outside force acts upon the free electrons. This force is called, in a generic way, of *electromotive force* (EMF). Usually, it is of *electrical* nature ($F = eE$).

Here, it is shown that the electrical flow can also be achieved by means of *gravitational* forces ($F = m_e g$). The *Gravitational Shielding Effect* (BR Patent Number: PI0805046-5, July 31, 2008 [4]), shows that a battery of Gravitational Shieldings can strongly intensify the gravitational acceleration in any direction and, in this way, it is possible to *produce strong gravitational accelerations on the free electrons of a conductor* in order to obtain electrical current.

2. Theory

From the quantization of gravity it follows that the *gravitational mass* m_g and the *inertial mass* m_i are correlated by means of the following factor [1]:

$$\chi = \frac{m_g}{m_{i0}} = \left\{ 1 - 2 \left[\sqrt{1 + \left(\frac{\Delta p}{m_{i0} c} \right)^2} - 1 \right] \right\} \quad (1)$$

where m_{i0} is the *rest* inertial mass of the particle and Δp is the variation in the particle's *kinetic momentum*; c is the speed of light.

When Δp is produced by the absorption of a photon with wavelength λ , it is expressed by $\Delta p = h/\lambda$. In this case, Eq. (1) becomes

$$\frac{m_g}{m_{i0}} = \left\{ 1 - 2 \left[\sqrt{1 + \left(\frac{h/m_{i0}c}{\lambda} \right)^2} - 1 \right] \right\}$$

$$= \left\{ 1 - 2 \left[\sqrt{1 + \left(\frac{\lambda_0}{\lambda} \right)^2} - 1 \right] \right\} \quad (2)$$

where $\lambda_0 = h/m_{i0}c$ is the *De Broglie wavelength* for the particle with *rest* inertial mass m_{i0} .

It has been shown that there is an additional effect - *Gravitational Shielding* effect - produced by a substance whose gravitational mass was reduced or made negative [5]. The effect extends beyond substance (gravitational shielding), up to a certain distance from it (along the central axis of gravitational shielding). This effect shows that in this region the gravity acceleration, g_1 , is reduced at the same proportion, i.e., $g_1 = \chi_1 g$ where $\chi_1 = m_g/m_{i0}$ and g is the gravity acceleration *before* the gravitational shielding). Consequently, *after a second gravitational shielding*, the gravity will be given by $g_2 = \chi_2 g_1 = \chi_1 \chi_2 g$, where χ_2 is the value of the ratio m_g/m_{i0} for the *second* gravitational shielding. In a generalized way, we can write that after the n th gravitational shielding the gravity, g_n , will be given by

$$g_n = \chi_1 \chi_2 \chi_3 \dots \chi_n g \quad (3)$$

This possibility shows that, by means of a battery of gravitational shieldings, we can make particles acquire enormous accelerations. In practice, this can lead to the conception of powerful particles accelerators, kinetic weapons or weapons of shockwaves.

From Electrodynamics we know that when an electromagnetic wave with frequency f and velocity c incides on a material with relative permittivity ϵ_r , relative magnetic permeability μ_r and electrical conductivity σ , its *velocity is reduced* to $v = c/n_r$, where n_r is the index of refraction of the material, given by [6]

$$n_r = \frac{c}{v} = \sqrt{\frac{\epsilon_r \mu_r}{2} \left(\sqrt{1 + (\sigma/\omega\epsilon)^2} + 1 \right)} \quad (4)$$

If $\sigma \gg \omega\epsilon$, $\omega = 2\pi f$, Eq. (4) reduces to

$$n_r = \sqrt{\frac{\mu_r \sigma}{4\pi\epsilon_0 f}} \quad (5)$$

Thus, the wavelength of the incident radiation (See Fig. 1) becomes

$$\lambda_{\text{mod}} = \frac{v}{f} = \frac{c/f}{n_r} = \frac{\lambda}{n_r} = \sqrt{\frac{4\pi}{\mu f \sigma}} \quad (6)$$

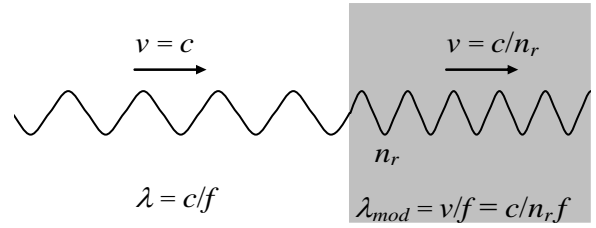

Fig. 1 – *Modified Electromagnetic Wave*. The wavelength of the electromagnetic wave can be strongly reduced, but its frequency remains the same.

If a lamina with thickness equal to ξ contains n atoms/ m^3 , then the number of atoms per area unit is $n\xi$. Thus, if the electromagnetic radiation with frequency f incides on an area S of the lamina it reaches $nS\xi$ atoms. If it incides on the *total area of the lamina*, S_f , then the total number of atoms reached by the radiation is $N = nS_f \xi$. The number of atoms per unit of volume, n , is given by

$$n = \frac{N_0 \rho}{A} \quad (7)$$

where $N_0 = 6.02 \times 10^{26}$ atoms/kmole is the Avogadro's number; ρ is the matter density of the lamina (in kg/m^3) and A is the molar mass($kg/kmole$).

When an electromagnetic wave incides on the lamina, it strikes N_f front atoms, where $N_f \cong (nS_f)\phi_m$, ϕ_m is the “diameter” of the atom. Thus, the electromagnetic wave incides effectively on an area $S = N_f S_m$, where $S_m = \frac{1}{4} \pi \phi_m^2$ is the cross section area of one atom.

After these collisions, it carries out $n_{collisions}$ with the other atoms (See Fig.2).

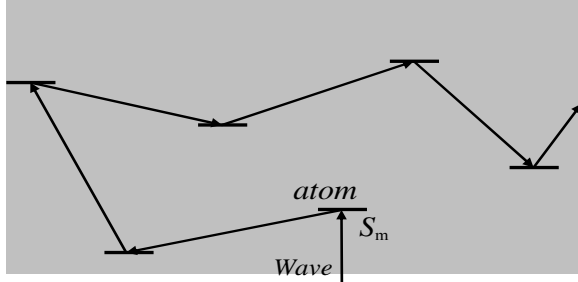

Fig. 2 – Collisions inside the lamina.

Thus, the total number of collisions in the volume $S\xi$ is

$$\begin{aligned} N_{collisions} &= N_f + n_{collisions} = n_l S \phi_m + (n_l S \xi - n_m S \phi_m) = \\ &= n_l S \xi \end{aligned} \quad (8)$$

The power density, D , of the radiation on the lamina can be expressed by

$$D = \frac{P}{S} = \frac{P}{N_f S_m} \quad (9)$$

We can express the *total mean number of collisions in each atom*, n_1 , by means of the following equation

$$n_1 = \frac{n_{total \ photons} N_{collisions}}{N} \quad (10)$$

Since in each collision a *momentum* h/λ is transferred to the atom, then the *total momentum* transferred to the lamina will be $\Delta p = (n_1 N) h/\lambda$. Therefore, in accordance with Eq. (1), we can write that

$$\begin{aligned} \frac{m_g(t)}{m_{i0}(t)} &= \left\{ 1 - 2 \left[\sqrt{1 + \left[(n_1 N) \frac{\lambda_0}{\lambda} \right]^2} - 1 \right] \right\} = \\ &= \left\{ 1 - 2 \left[\sqrt{1 + \left[n_{total \ photons} N_{collisions} \frac{\lambda_0}{\lambda} \right]^2} - 1 \right] \right\} \end{aligned} \quad (11)$$

Since Eq. (8) gives $N_{collisions} = n_l S \xi$, we get

$$n_{total \ photons} N_{collisions} = \left(\frac{P}{hf^2} \right) (n_l S \xi) \quad (12)$$

Substitution of Eq. (12) into Eq. (11) yields

$$\frac{m_g(t)}{m_{i0}(t)} = \left\{ 1 - 2 \left[\sqrt{1 + \left[\left(\frac{P}{hf^2} \right) (n_l S \xi) \frac{\lambda_0}{\lambda} \right]^2} - 1 \right] \right\} \quad (13)$$

Substitution of P given by Eq. (9) into Eq. (13) gives

$$\frac{m_g(t)}{m_{i0}(t)} = \left\{ 1 - 2 \left[\sqrt{1 + \left[\left(\frac{N_f S_m D}{f^2} \right) \left(\frac{n_l S \xi}{m_{i0}(t) c} \right) \frac{1}{\lambda} \right]^2} - 1 \right] \right\} \quad (14)$$

Substitution of $N_f \cong (n_l S_f) \phi_m$ and $S = N_f S_m$ into Eq. (14) results

$$\frac{m_g(t)}{m_{i0}(t)} = \left\{ 1 - 2 \left[\sqrt{1 + \left[\left(\frac{n_l^3 S_f^2 S_m^2 \phi_m^2 D}{m_{i0}(t) c f^2} \right) \frac{1}{\lambda} \right]^2} - 1 \right] \right\} \quad (15)$$

where $m_{i0}(t) = \rho_{(t)} V_{(t)}$.

Now, considering that the lamina is inside an ELF electromagnetic field with E and B , then we can write that [7]

$$D = \frac{n_r(t) E^2}{2\mu_0 c} \quad (16)$$

Substitution of Eq. (16) into Eq. (15) gives

$$\frac{m_g(t)}{m_{i0}(t)} = \left\{ 1 - 2 \left[\sqrt{1 + \left[\left(\frac{n_r(t) n_l^3 S_f^2 S_m^2 \phi_m^2 E^2}{2\mu_0 m_{i0}(t) c^2 f^2} \right) \frac{1}{\lambda} \right]^2} - 1 \right] \right\} \quad (17)$$

In the case in which the area S_f is just the *area of the cross-section of the lamina* (S_α), we obtain from Eq. (17), considering that $m_{i0}(t) = \rho_{(t)} S_\alpha \xi$, the following expression

$$\frac{m_{g(l)}}{m_{i0(l)}} = \left\{ 1 - 2 \left[\sqrt{1 + \left[\left(\frac{n_{r(l)} n_l^3 S_\alpha^2 S_m^2 \phi_m^2 E^2}{2 \mu_0 \rho(l) c^2 f^2} \right) \frac{1}{\lambda} \right]^2} - 1 \right] \right\} \quad (18)$$

According to Eq. (6) we have

$$\lambda = \lambda_{\text{mod}} = \frac{v}{f} = \frac{c}{n_{r(l)} f} \quad (19)$$

Substitution of Eq. (19) into Eq. (18) gives

$$\frac{m_{g(l)}}{m_{i0(l)}} = \left\{ 1 - 2 \left[\sqrt{1 + \frac{n_{r(l)}^4 n_l^6 S_\alpha^2 S_m^4 \phi_m^4 E^4}{4 \mu_0^2 \rho(l)^2 c^6 f^2}} - 1 \right] \right\} \quad (20)$$

Note that $E = E_m \sin \omega t$. The average value for E^2 is equal to $\frac{1}{2} E_m^2$ because E varies sinusoidally (E_m is the maximum value for E). On the other hand, $E_{rms} = E_m / \sqrt{2}$. Consequently we can change E^4 by E_{rms}^4 , and the equation above can be rewritten as follows

$$\chi = \frac{m_{g(l)}}{m_{i0(l)}} = \left\{ 1 - 2 \left[\sqrt{1 + \frac{n_{r(l)}^4 n_l^6 S_\alpha^2 S_m^4 \phi_m^4 E_{rms}^4}{4 \mu_0^2 \rho(l)^2 c^6 f^2}} - 1 \right] \right\} \quad (21)$$

Now consider the system shown in Fig.3. It was designed to convert *Gravitational Energy* directly into *Electrical Energy*. Thus, we can say that it is a *Gravitational EMF Source*.

Inside the system there is a *dielectric tube* ($\epsilon_r \cong 1$) with the following characteristics: $\alpha = 8\text{mm}$ (diameter), $S_\alpha = \pi \alpha^2 / 4 = 5.03 \times 10^{-5} \text{m}^2$. Inside the tube there is a *Lead sphere* ($\rho_s = 11340 \text{Kg/m}^3$) with 4mm radius and mass $M_{gs} = 3.04 \times 10^{-3} \text{kg}$. The tube is filled with *air* at ambient temperature and 1atm. Thus, inside the tube, the air density is

$$\rho_{air} = 1.2 \text{ kg} \cdot \text{m}^{-3} \quad (22)$$

The number of atoms of air (Nitrogen) per unit of volume, n_{air} , according to Eq.(7), is given by

$$n_{air} = \frac{N_0 \rho_{air}}{A_N} = 5.16 \times 10^{25} \text{ atoms/m}^3 \quad (23)$$

The *parallel metallic plates* (p), shown in Fig.3 are subjected to different drop voltages. The two sets of plates (D), placed on the extremes of the tube, are subjected to $V_{(D)rms} = 134.72 \text{ V}$ at $f = 60\text{Hz}$, while the central set of plates (A) is subjected to $V_{(A)rms} = 273.98 \text{ V}$ at $f = 60\text{Hz}$. Since $d = 14\text{mm}$, then the intensity of the electric field, which passes through the 36 *cylindrical air laminas* (each one with 5mm thickness) of the two sets (D), is

$$E_{(D)rms} = V_{(D)rms} / d = 9.623 \times 10^3 \text{ V/m}$$

and the intensity of the electric field, which passes through the 19 *cylindrical air laminas* of the central set (A), is given by

$$E_{(A)rms} = V_{(A)rms} / d = 1.957 \times 10^4 \text{ V/m}$$

Note that the *metallic rings* (5mm thickness) are positioned in such way to block the electric field out of the cylindrical air laminas. The objective is to turn each one of these laminas into a *Gravity Control Cells* (GCC) [5]. Thus, the system shown in Fig. 3 has 3 sets of GCC. Two with 18 GCC each, and one with 19 GCC. The two sets with 18 GCC each are positioned at the extremes of the tube (D). They work as *gravitational decelerator* while the other set with 19 GCC (A) works as a *gravitational accelerator*, intensifying the gravity acceleration produced by the mass M_{gs} of the Lead sphere. According to Eq. (3), this gravity, after the 19th GCC becomes $g_{19} = \chi^{19} GM_{gs} / r_0^2$, where $\chi = m_{g(l)} / m_{i(l)}$ given by Eq. (21) and $r_0 = 9\text{mm}$ is the distance between the center of the Lead sphere and the surface of the first GCC of the set (A).

The objective of the sets (D), with 18 GCC each, is to reduce strongly the value of the external gravity along the axis of the tube. In this case, the value of the external gravity, g_{ext} , is reduced by the factor $\chi_d^{18} g_{ext}$, where $\chi_d = 10^{-2}$. For example, if the base BS of the system is positioned on the Earth

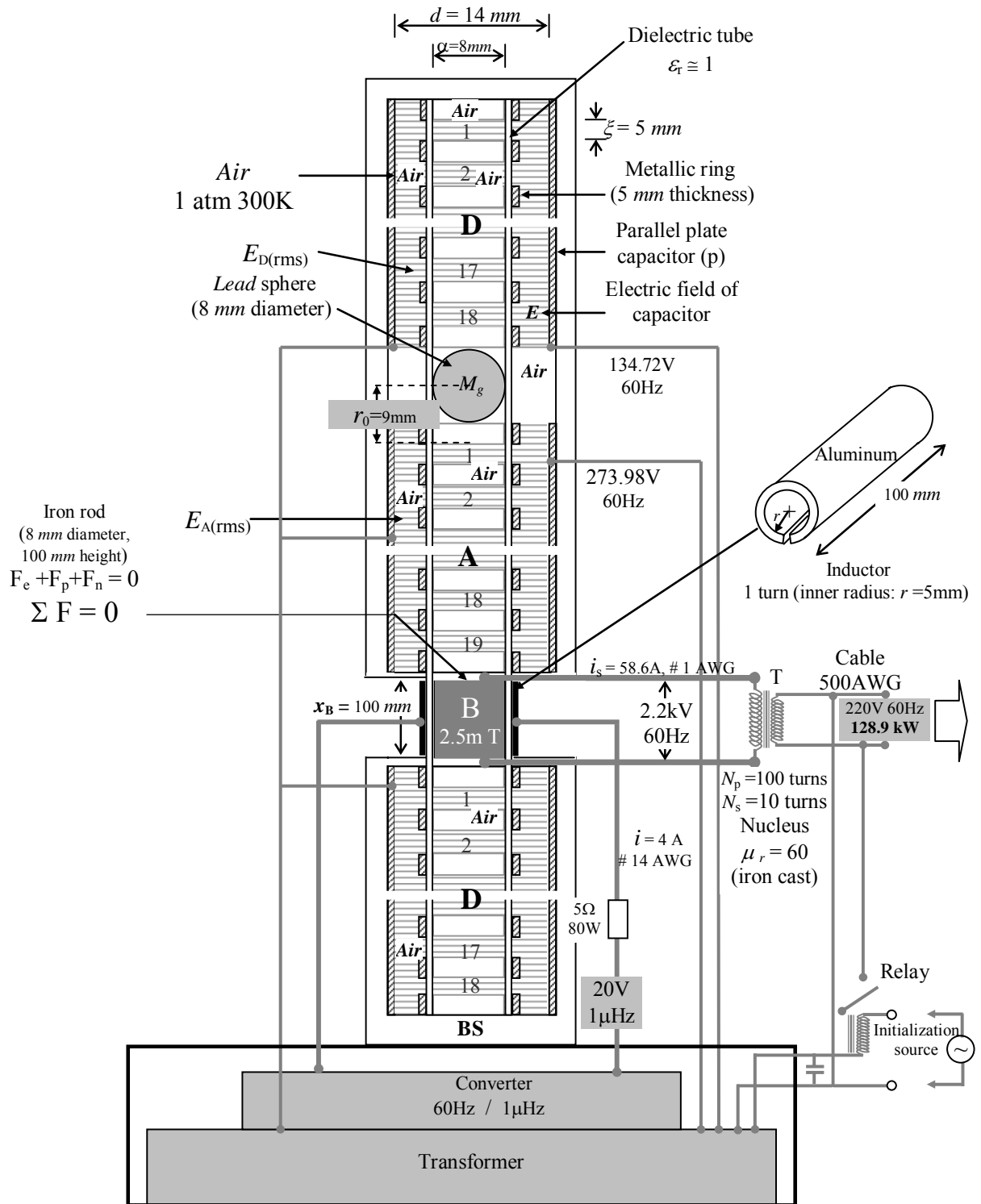

Fig. 3 – A Gravitational EMF Source (Developed from a process patented in July, 31 2008, PI0805046-5)

surface, then $g_{ext} = 9.81 m/s^2$ is reduced to $\chi_d^{18} g_{ext}$ and, after the set A, it is increased by χ^{19} . Since the system is designed for $\chi = -6.4138$, then the gravity acceleration on the sphere becomes $\chi^{19} \chi_d^{18} g_{ext} = 2.1 \times 10^{20} m/s^2$, this value is much smaller than $g_{sphere} = GM_{gs}/r_s^2 = 1.27 \times 10^8 m/s^2$.

The values of χ and χ_d , according to Eq. (21) are given by

$$\chi = \left\{ 1 - 2 \left[\sqrt{1 + \frac{n_{r(air)}^4 n_{air}^6 S_\alpha^2 S_m^4 \phi_m^4 E_{(A)rms}^4}{4\mu_0^2 \rho_{air}^2 c^6 f^2}} - 1 \right] \right\} = \left\{ 1 - 2 \left[\sqrt{1 + 1.44 \times 10^{-16} E_{(A)rms}^4} - 1 \right] \right\} \quad (24)$$

$$\chi_d = \left\{ 1 - 2 \left[\sqrt{1 + \frac{n_{r(air)}^4 n_{air}^6 S_\alpha^2 S_m^4 \phi_m^4 E_{(D)rms}^4}{4\mu_0^2 \rho_{air}^2 c^6 f^2}} - 1 \right] \right\} = \left\{ 1 - 2 \left[\sqrt{1 + 1.44 \times 10^{-16} E_{(D)rms}^4} - 1 \right] \right\} \quad (25)$$

where $n_{r(air)} = \sqrt{\epsilon_r \mu_r} \cong 1$, since $(\sigma \ll \omega \epsilon)^*$; $n_{air} = 5.16 \times 10^{25} atoms/m^3$, $\phi_m = 1.55 \times 10^{-10} m$, $S_m = \pi \phi_m^2 / 4 = 1.88 \times 10^{-20} m^2$ and $f = 60 Hz$. Since $E_{(A)rms} = 1.957 \times 10^4 V/m$ and $E_{(D)rms} = 9.623 V \times 10^3 / m$, we get

$$\chi = -6.4138 \quad (26)$$

and

$$\chi_d \cong 10^{-2} \quad (27)$$

Note that there is a *uniform magnetic field*, B , through the *Iron rod*. Then, the *gravitational forces* due to the gravitational mass of the sphere (M_{gs}) acting on *electrons* (F_e), *protons* (F_p) and *neutrons* (F_n) of the

* The electrical conductivity of air, *inside the dielectric tube*, is equal to the electrical conductivity of Earth's atmosphere near the land, whose average value is $\sigma_{air} \cong 1 \times 10^{-14} S/m$ [8].

Iron rod, are respectively expressed by the following relations

$$F_e = m_{ge} a_e = \chi_{Be} m_e \left(\chi^7 G \frac{M_{gs}}{r_0^2} \right) \quad (28)$$

$$F_p = m_{gp} a_p = \chi_{Bp} m_p \left(\chi^7 G \frac{M_{gs}}{r_0^2} \right) \quad (29)$$

$$F_n = m_{gn} a_n = \chi_{Bn} m_n \left(\chi^7 G \frac{M_{gs}}{r_0^2} \right) \quad (30)$$

The factors χ_B are due to the electrons, protons and neutrons are inside the *magnetic field B*.

In order to make null the resultant of these forces in the Iron (and also in the sphere) we must have $F_e = F_p + F_n$, i.e.,

$$m_e \chi_{Be} = m_p \chi_{Bp} + m_n \chi_{Bn} \quad (31)$$

It is important to note that *the set with 19 GCC (A) cannot be turned on before the magnetic field B is on*. Because the gravitational accelerations on the *Iron rod* and *Lead sphere* will be enormous ($\chi^{19} GM_{gs}/r_0^2 \cong 5.4 \times 10^6 m/s^2$), and will explode the device.

The force F_e is the electromotive force (EMF), which produces the electrical current. Here, this force has *gravitational nature*. The corresponding force of *electrical nature* is $F_e = eE$. Thus, we can write that

$$m_{ge} a_e = eE \quad (32)$$

The electrons inside the *Iron rod* (See Fig. 3) are subjected to the gravity acceleration produced by the sphere, and increased by the 19 GCC in the region (A). The result is

$$a_e = \chi^{19} g_s = \chi^{19} G \frac{M_{gs}}{r_0^2} \quad (33)$$

Comparing Eq. (32) with Eq.(33), we obtain

$$E = \left(\frac{m_{ge}}{e} \right) \chi^{19} G \frac{M_{gs}}{r_0^2} \quad (34)$$

The electron mobility, μ_e , considering various scattering mechanisms can be obtained by solving the Boltzmann equation in the relaxation time approximation. The result is [9]

$$\mu_e = \frac{e\langle\tau\rangle}{m_{ge}} \quad (35)$$

where $\langle\tau\rangle$ is the average relaxation time over the electron energies and m_{ge} is the gravitational mass of electron, which is the effective mass of electron.

Since $\langle\tau\rangle$ can be expressed by $\langle\tau\rangle = m_{ge}\sigma/ne^2$ [10], then Eq. (35) can be written as follows

$$\mu_e = \frac{\sigma}{ne} \quad (36)$$

Thus, the *drift velocity* will be expressed by

$$v_d = \mu_e E = \frac{\sigma}{ne} \left(\frac{m_{ge}}{e} \right) \chi^{19} G \frac{M_{gs}}{r_0^2} \quad (37)$$

and the *electrical current density* expressed by

$$j_e = \rho_{qe} v_d = \sigma_{iron} \left(\frac{m_{ge}}{e} \right) \chi^{19} G \frac{M_{gs}}{r_0^2} \quad (38)$$

where $\rho_{qe} = ne$, and $m_{ge} = \chi_{Be} m_e$.

Therefore, Eq. (38) reduces to

$$j_e = \sigma_{iron} \left(\frac{m_e}{e} \right) \chi_{Be} \chi^{19} G \frac{M_{gs}}{r_0^2} \quad (39)$$

In order to calculate the expressions of χ_{Be} , χ_{Bp} and χ_{Bn} we start from Eq. (17), for the particular case of *single electron* in the region subjected to the magnetic field B (*Iron rod*). In this case, we must substitute $n_{r(t)}$ by $n_{riron} = (\mu_{r(iron)} \sigma_{iron} / 4\pi\epsilon_0 f)^{\frac{1}{2}}$; n_l by $1/V_e = 1/\frac{4}{3}\pi r_e^3$ (r_e is the electrons radius), S_f by $(SSA_e) \rho_e V_e$ (SSA_e is the *specific surface area* for electrons in this case: $SSA_e = \frac{1}{2} A_e / m_e = \frac{1}{2} A_e / \rho_e V_e = 2\pi r_e^2 / \rho_e V_e$), S_m by $S_e = \pi r_e^2$, ξ by $\phi_m = 2r_e$ and $m_{i0(t)}$ by m_e . The result is

$$\chi_{Be} = \left\{ 1 - 2 \left[\sqrt{1 + \frac{45.56\pi^2 r_e^4 n_{riron}^2 E^4}{\mu_0^2 m_e^2 c^4 f^4 \lambda^2}} - 1 \right] \right\} \quad (40)$$

Electrodynamics tells us that $E_{rms} = v B_{rms} = (c/n_{r(iron)}) B_{rms}$, and Eq. (19) gives $\lambda = \lambda_{mod} = (4\pi/\mu_{iron} \sigma_{iron} f)$. Substitution of these expressions into Eq. (40) yields

$$\chi_{Be} = \left\{ 1 - 2 \left[\sqrt{1 + \frac{45.56\pi^2 r_e^4 B_{rms}^4}{\mu_0^2 m_e^2 c^2 f^2}} - 1 \right] \right\} \quad (41)$$

Similarly, in the case of *proton* and *neutron* we can write that

$$\chi_{Bp} = \left\{ 1 - 2 \left[\sqrt{1 + \frac{45.56\pi^2 r_p^4 B_{rms}^4}{\mu_0^2 m_p^2 c^2 f^2}} - 1 \right] \right\} \quad (42)$$

$$\chi_{Bn} = \left\{ 1 - 2 \left[\sqrt{1 + \frac{45.56\pi^2 r_n^4 B_{rms}^4}{\mu_0^2 m_n^2 c^2 f^2}} - 1 \right] \right\} \quad (43)$$

The radius of *free electron* is $r_e = 6.87 \times 10^{-14} m$ (See *Appendix A*) and the radius of *protons inside the atoms* (nuclei) is $r_p = 1.2 \times 10^{-15} m$, $r_n \cong r_p$, then we obtain from Eqs. (41) (42) and (43) the following expressions:

$$\chi_{Be} = \left\{ 1 - 2 \left[\sqrt{1 + 8.49 \times 10^4 \frac{B_{rms}^4}{f^2}} - 1 \right] \right\} \quad (44)$$

$$\chi_{Bn} \cong \chi_{Bp} = \left\{ 1 - 2 \left[\sqrt{1 + 2.35 \times 10^{-9} \frac{B_{rms}^4}{f^2}} - 1 \right] \right\} \quad (45)$$

Then, from Eq. (31) it follows that

$$m_e \chi_{Be} \cong 2m_p \chi_{Bp} \quad (46)$$

Substitution of Eqs. (44) and (45) into Eq. (46) gives

$$\frac{\left\{ 1 - 2 \left[\sqrt{1 + 8.49 \times 10^4 \frac{B_{rms}^4}{f^2}} - 1 \right] \right\}}{\left\{ 1 - 2 \left[\sqrt{1 + 2.35 \times 10^{-9} \frac{B_{rms}^4}{f^2}} - 1 \right] \right\}} = 3666.3 \quad (47)$$

For $f = 1\mu Hz$, we get

$$\frac{\left\{ 1 - 2 \left[\sqrt{1 + 8.49 \times 10^6 B_{rms}^4} - 1 \right] \right\}}{\left\{ 1 - 2 \left[\sqrt{1 + 2.35 \times 10^{-7} B_{rms}^4} - 1 \right] \right\}} = 3666.3 \quad (48)$$

whence we obtain

$$B_{rms} = 2.5m T \quad (49)$$

Consequently, Eq. (44) and (45) yields

$$\chi_{Be} = -3666.3 \quad (50)$$

and

$$\chi_{Bn} \cong \chi_{Bp} \cong 0.999 \quad (51)$$

In order to the forces F_e and F_p have *contrary direction* (such as occurs in the case, in which the nature of the electromotive force is electrical) we must have $\chi_{Be} < 0$ and $\chi_{Bn} \cong \chi_{Bp} > 0$ (See equations (28) (29) and (30)), i.e.,

$$\left\{ 1 - 2 \left[\sqrt{1 + 8.49 \times 10^4 \frac{B_{rms}^4}{f^2}} - 1 \right] \right\} < 0 \quad (52)$$

and

$$\left\{ 1 - 2 \left[\sqrt{1 + 235 \times 10^9 \frac{B_{rms}^4}{f^2}} - 1 \right] \right\} > 0 \quad (53)$$

This means that we must have

$$0.06\sqrt{f} < B_{rms} < 151.86\sqrt{f} \quad (54)$$

In the case of $f = 1\mu\text{Hz} = 10^{-6}\text{Hz}$ the result is

$$6.5 \times 10^{-5}\text{T} < B_{rms} < 0.15\text{T} \quad (55)$$

Note the cylindrical format (1turn, $r = 5\text{mm}$) of the inductor (Figs. 3 and 6). By using only 1 turn it is possible to eliminate the *capacitive effect* between the turns. This is highly relevant in this case because the extremely-low frequency $f = 1\mu\text{Hz}$ would strongly increase the capacitive reactance (X_c) associated to the inductor. When a current i passes through this inductor, the value of B inside the *Iron rod* is given by $B = \mu_r \mu_0 i / x_B$ where $x_B = 100\text{mm}$ is inductor's length and $\mu_r = 4000$ (very pure Iron). However, the effective permeability is defined as $\mu_{(eff)} = \mu_r / (1 + (\mu_r - 1)N_m)$, where N_m is the average *demagnetizing factor* [11]. Since the iron rod has 5mm diameter and 100mm height, then we obtain the factor $\gamma = 100\text{mm} / 5\text{mm} = 20$ which gives $N_m = 0.02$ (See table V[12]). Therefore, we obtain $\mu_{r(eff)} = 494$. Thus, for $B_{rms} = 2.5\text{mT}$ (See Eq. (49)) i.e., $B = \mu_{r(eff)} \mu_0 i / x_B = 2.5\text{mT}$, the value of i must be $i = 4\text{A}$. Then, the resistor in Fig.3. must have $20\text{V} / 4\text{A} = 5\Omega$. The dissipated power is 80W .

Let us now calculate the *current density through the Iron rod* (Fig. 3). According to Eq. (39) we have

$$j_e = \sigma_{iron} \left(\frac{m_e}{e} \right) \chi_{Be} \chi^{19} G \frac{M_{gs}}{r_0^2}$$

Since $\sigma_{iron} = 1.03 \times 10^7 \text{S/m}$, $\chi = -6.4138$, $\chi_{Be} = -3666.3$, $M_{gs} = 3.04 \times 10^{-3} \text{kg}$ and $r_0 = 9\text{mm}$, we obtain

$$j_e = 1.164 \times 10^6 \text{A/m}^2$$

Given that $S_\alpha = \pi\alpha^2 / 4 = 5.03 \times 10^{-5} \text{m}^2$ we get

$$i_{source} = j_e S_\alpha \cong 58.6 \text{A}$$

The resistance of the Iron rod is

$$R_{source} = \left(\frac{x_B}{\sigma_{iron} S_\alpha} \right) = 1.93 \times 10^{-4} \Omega$$

Thus, the *dissipated power* by the Iron rod is

$$P_d = R_{source} i_{source}^2 \cong 0.66\text{W} \quad (56)$$

Note that this *Gravitational EMF source* is a *Current Source*. As we known, a *Current Source* is a device that keeps invariable the electric current between its terminals. So, if the source is connected to an external load, and the resistance of the load varies, then the own source will increase or decrease its output voltage in order to maintain invariable the value of the current in the circuit.

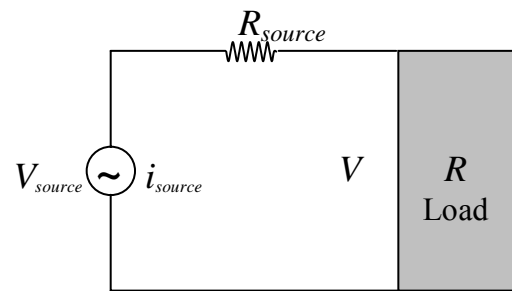

Fig. 4 – Current Source

Based on Kirchhoff's laws we can express the electric voltage between the terminals of the Current Source, V_s , by means of the following relation (See Fig.4):

$$V_{source} = R_{source} i_{source} + V$$

where V is the voltage applied on the charge.

The transformer T connected to Gravitational EMF Source (See Fig. 3) is

designed[†] to make the voltage $V = 2.2kV @ 60Hz$. Since $R_{source} i_{source} \ll V$, then we can write that $V_{source} \cong V$. Thus, in the primary circuit, the voltage is $V_p = V_{source} \cong V = 2.2kV$ and the current is $i_p = i_{source} = 58.6A$; the winding turns ratio is $N_p/N_s = 10$; thus, in the secondary circuit the output voltage is $V_s = 220V @ 60Hz$ and the current is $i_s = 586A$. Consequently, the source output power is

$$P = V_s i_s = 128.9kW$$

Note that, in order to *initializing* the Gravitational EMF Source, is used an external source, which is removed after the initialization of the Gravitational EMF Source.

Now it will be shown that this Gravitational EMF source can be *miniaturized*.

We start making $x_B = 10mm$ and $\xi = 0.5mm$; $\alpha = 2mm$, $d_A = 8mm$, $d_D = 16mm$ and $r_0 = 1.5mm$ (See Fig. 5). The sphere with 2mm diameter is now of *Tungsten carbide* (W+Cobalt) with $15,630kg/m^3$ density. Then $M_{gs} = 6.54 \times 10^{-5} kg$ and $S_\alpha = 3.14 \times 10^6 m^2$. Thus, for $f = 1\mu Hz$ Eq.(21) gives

$$\chi = \left\{ 1 - 2 \left[\sqrt{1 + 2.03 \times 10^{-3} E_{(A)rms}^4} - 1 \right] \right\} \quad (57)$$

For $V_{A(rms)} = 93.5mV$ and $d_A = 8mm$ we get $E_{(A)rms} = 11.688V/m$, and Eq. (57) yields

$$\chi = -6.236$$

For $V_{D(rms)} = 93.5mV$ and $d_D = 16mm$ we get $E_{(D)rms} = 5.844V/m$ and $\chi_d \cong -0.01$.

[†] The impedances are respectively,

$$Z_p \cong 2\pi f L_p = 2\pi f (\mu_r \mu_0 N_p^2 A_p / l_p) = 14.36\Omega$$

$$Z_s \cong 2\pi f L_s = 2\pi f (\mu_r \mu_0 N_s^2 A_s / l_s) = 6.154 \times 10^{-4}\Omega$$

$$Z_{p(total)} = Z_p + Z_{reflected} = Z_p + (N_p/N_s) Z_s = 37.56\Omega$$

where $\mu_r = 60$ (iron cast), $N_p = 100$, $N_s = 10$,

$$l_p = l_s = 0.18m, \phi_p = 107.6mm, \phi_s = 136.8mm,$$

$$A_p = 0.0091m^2, A_s = 0.0147m^2.$$

Since $\sigma_{iron} = 1.03 \times 10^7 S/m$ and $\chi_{Be} = -3666.3$, then the value of j_e is

$$j_e = \sigma_{iron} \left(\frac{m_e}{e} \right) \chi_{Be} \chi^{19} G \frac{M_{gs}}{r_0^2} = 5.29 \times 10^5 A/m^2$$

and

$$i_{source} = j_e S_\alpha \cong 1.66 A$$

The resistance of the iron rod is given by

$$R_{source} = \left(\frac{x_B}{\sigma_{iron} S_\alpha} \right) = 3.1 \times 10^{-4}\Omega$$

Thus, the *dissipated power* by the Iron rod is

$$P_d = R_{source} i_{source}^2 \cong 0.9mW$$

In the case of the *miniaturized source*, the iron rod has 2mm diameter and 10mm height, then we obtain the factor $\gamma = 10mm / 2mm = 5$ which gives $N_m = 0.06$ (See table V[12]). Therefore, we obtain $\mu_{r(eff)} = 16.6$.

Since $V_s = V_{A(rms)} = V_{D(rms)} = 93.5mV$

and the resistance of the resistor R_1 is $21.6m\Omega / 31mW$ (See Fig.5), then the current from the *first* source is $i = 1.2A$. Thus, we get $B = \mu_{r(eff)} \mu_0 i / x_B = 2.5mT$.

Since the current through the *second source* is $i_{source} = 1.66A$, and, if the voltage required by the charge, is $V = 3.7V$ (usual lithium batteries' voltage), then the source voltage is given by

$$V_{source} = R_{source} i_{source} + V \cong 3.7V$$

Consequently, the miniaturized source can provide the power:

$$P = V_{source} i_{source} = (3.7V) 1.66 A \cong 6.1W$$

This is the magnitude of the power of lithium batteries used in mobiles. Note that the *miniaturized source of Gravitational EMF* does *not need to be recharged* and it occupies a volume (8mm x 70mm x 80mm. See Fig.6) similar to the volume of the mobile batteries. In addition, note that the dimensions of this miniaturized source can be further reduced (possibly down to a few *millimeters* or less).

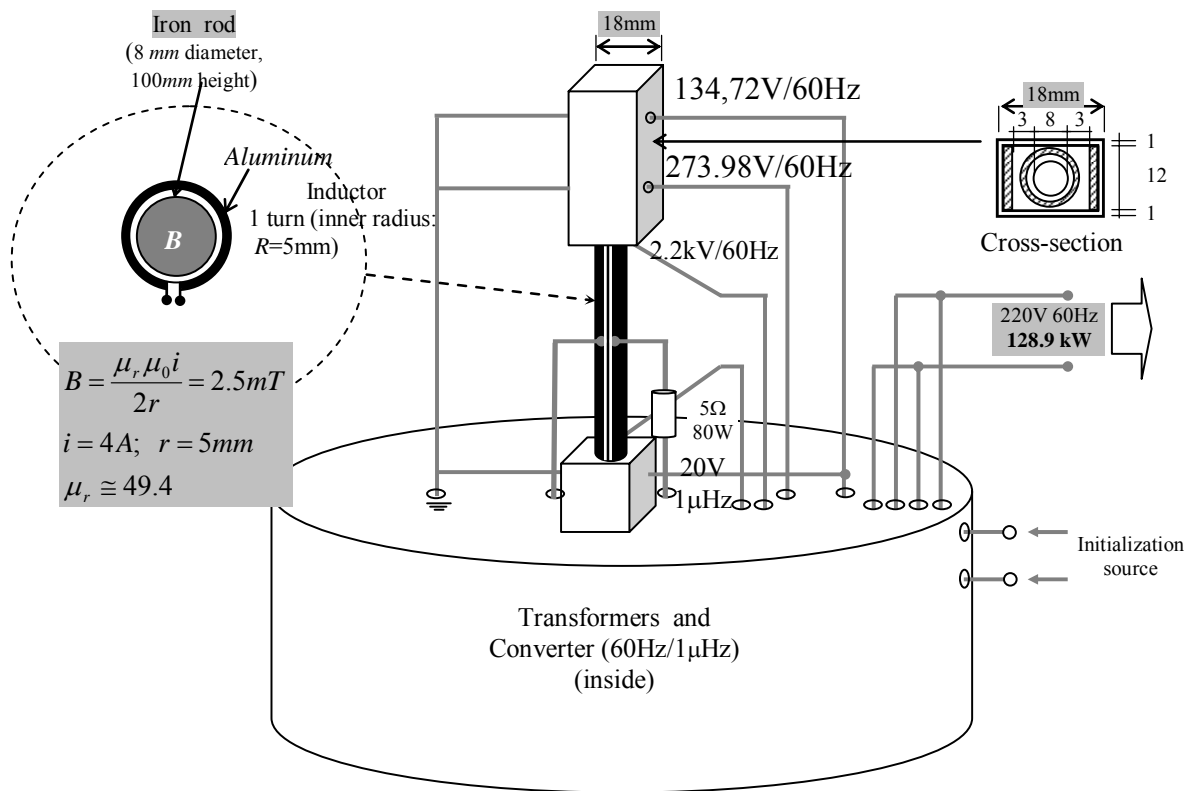

High-power Source

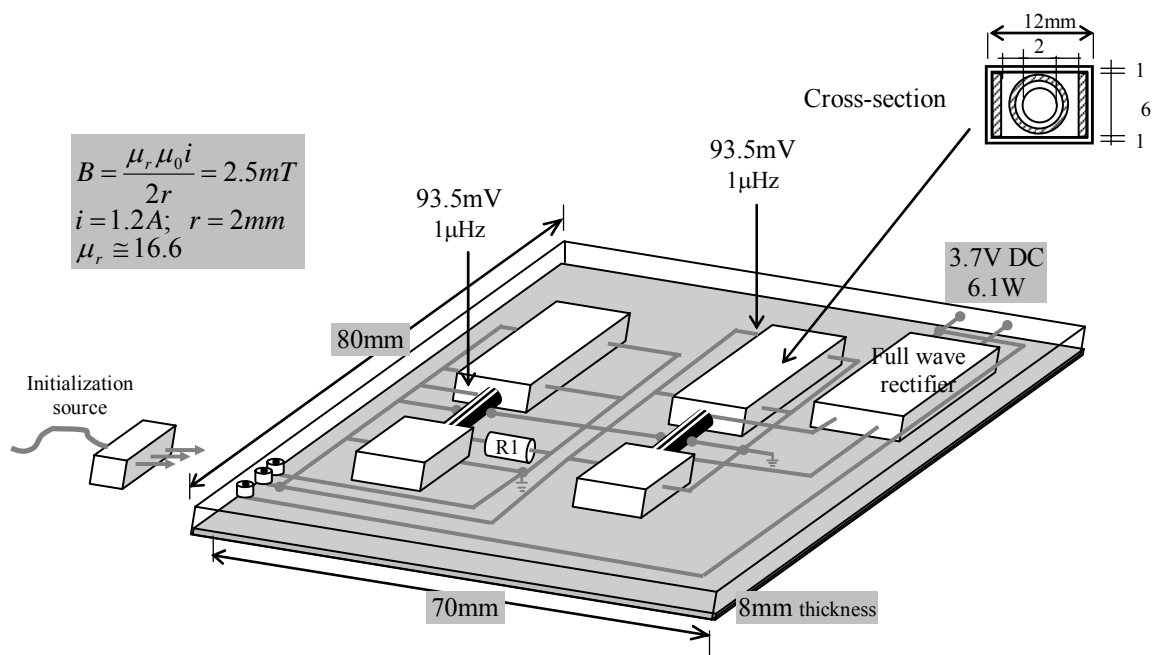

Low-power Source

Fig. 6 – Schematic Diagram in 3D of the *Gravitational EMF Sources*

Appendix A: The “Geometrical Radii” of Electron and Proton

It is known that the frequency of oscillation of a simple spring oscillator is

$$f = \frac{1}{2\pi} \sqrt{\frac{K}{m}} \quad (\text{A1})$$

where m is the inertial mass attached to the spring and K is the spring constant (in $\text{N}\cdot\text{m}^{-1}$). In this case, the restoring force exerted by the spring is linear and given by

$$F = -Kx \quad (\text{A2})$$

where x is the displacement from the equilibrium position.

Now, consider the gravitational force: For example, above the surface of the Earth, the force follows the familiar Newtonian function, i.e., $F = -GM_{g\oplus}m_g/r^2$, where $M_{g\oplus}$ the mass of Earth is, m_g is the gravitational mass of a particle and r is the distance between the centers. Below Earth's surface the force is linear and given by

$$F = -\frac{GM_{g\oplus}m_g}{R_{\oplus}^3} r \quad (\text{A3})$$

where R_{\oplus} is the radius of Earth.

By comparing (A3) with (A2) we obtain

$$\frac{K}{m_g} = \frac{K}{\chi m} = \frac{GM_{g\oplus}}{R_{\oplus}^3} \left(\frac{r}{x}\right) \quad (\text{A4})$$

Making $x = r = R_{\oplus}$, and substituting (A4) into (A1) gives

$$f = \frac{1}{2\pi} \sqrt{\frac{GM_{g\oplus}\chi}{R_{\oplus}^3}} \quad (\text{A5})$$

In the case of an *electron* and a *positron*, we substitute $M_{g\oplus}$ by m_{ge} , χ by χ_e and R_{\oplus} by R_e , where R_e is the radius of electron (or positron). Thus, Eq. (A5) becomes

$$f = \frac{1}{2\pi} \sqrt{\frac{Gm_{ge}\chi_e}{R_e^3}} \quad (\text{A6})$$

The value of χ_e varies with the density of energy [1]. When the electron and the positron are distant from each other and the local density of energy is small, the value of χ_e becomes very close to 1. However, when the electron and the positron are penetrating one another, the energy densities in each particle become very strong due to the proximity of their electrical charges e and, consequently, the value of χ_e strongly increases. In order to calculate the value of χ_e under these conditions ($x = r = R_e$), we start from the expression of correlation between *electric charge* q and *gravitational mass*, obtained in a previous work [1]:

$$q = \sqrt{4\pi\epsilon_0 G} m_{g(\text{imaginary})} i \quad (\text{A7})$$

where $m_{g(\text{imaginary})}$ is the *imaginary* gravitational mass, and $i = \sqrt{-1}$.

In the case of *electron*, Eq. (A7) gives

$$\begin{aligned} q_e &= \sqrt{4\pi\epsilon_0 G} m_{gd(\text{imaginary})} i = \\ &= \sqrt{4\pi\epsilon_0 G} (\chi_e m_{i0e(\text{imaginary})} i) = \\ &= \sqrt{4\pi\epsilon_0 G} \left(-\chi_e \frac{2}{\sqrt{3}} m_{i0e(\text{real})} i^2\right) = \\ &= \sqrt{4\pi\epsilon_0 G} \left(\frac{2}{\sqrt{3}} \chi_e m_{i0e(\text{real})}\right) = -1.6 \times 10^{-19} \text{C} \quad (\text{A8}) \end{aligned}$$

where we obtain

$$\chi_e = -1.8 \times 10^{21} \quad (\text{A9})$$

This is therefore, the value of χ_e increased by the strong density of energy produced by the electrical charges e of the two particles, under previously mentioned conditions.

Given that $m_{ge} = \chi_e m_{i0e}$, Eq. (A6) yields

$$f = \frac{1}{2\pi} \sqrt{\frac{G\chi_e^2 m_{i0e}}{R_e^3}} \quad (A10)$$

From Quantum Mechanics, we know that

$$hf = m_{i0} c^2 \quad (A11)$$

where h is the Planck's constant. Thus, in the case of $m_{i0} = m_{i0e}$ we get

$$f = \frac{m_{i0e} c^2}{h} \quad (A12)$$

By comparing (A10) and (A12) we conclude that

$$\frac{m_{i0e} c^2}{h} = \frac{1}{2\pi} \sqrt{\frac{G\chi_e^2 m_{i0e}}{R_e^3}} \quad (A13)$$

Isolating the radius R_e , we get:

$$R_e = \left(\frac{G}{m_{i0e}} \right)^{\frac{1}{3}} \left(\frac{\chi_e h}{2\pi c^2} \right)^{\frac{2}{3}} = 6.87 \times 10^{-14} m \quad (A14)$$

Compare this value with the *Compton sized electron*, which predicts $R_e = 3.86 \times 10^{-13} m$ and also with standardized result recently obtained of $R_e = 4 - 7 \times 10^{-13} m$ [13].

In the case of *proton*, we have

$$\begin{aligned} q_p &= \sqrt{4\pi\epsilon_0 G} m_{gp(\text{imaginar})} i = \\ &= \sqrt{4\pi\epsilon_0 G} (\chi_p m_{i0p(\text{imaginar})} i) = \\ &= \sqrt{4\pi\epsilon_0 G} \left(-\chi_p \frac{2}{\sqrt{3}} m_{i0p(\text{real})} i^2 \right) = \\ &= \sqrt{4\pi\epsilon_0 G} \left(\frac{2}{\sqrt{3}} \chi_p m_{i0p(\text{real})} \right) = -1.6 \times 10^{-19} C \quad (A15) \end{aligned}$$

where we obtain

$$\chi_p = -9.7 \times 10^{17} \quad (A16)$$

Thus, the result is

$$R_p = \left(\frac{G}{m_{i0p}} \right)^{\frac{1}{3}} \left(\frac{\chi_p h}{2\pi c^2} \right)^{\frac{2}{3}} = 3.72 \times 10^{-17} m \quad (A17)$$

Note that these radii, given by Equations (A14) and (A17), are the radii of *free* electrons and *free* protons (when the particle and antiparticle (in isolation) penetrate themselves mutually).

Inside the atoms (nuclei) the radius of protons is well-known. For example, protons, as the hydrogen nuclei, have a radius given by $R_p \cong 1.2 \times 10^{-15} m$ [14, 15]. The strong increase in respect to the value given by Eq. (A17) is due to the interaction with the electron of the atom.

Appendix B: An Experimental Setup for Testing a GCC with Air Nucleus

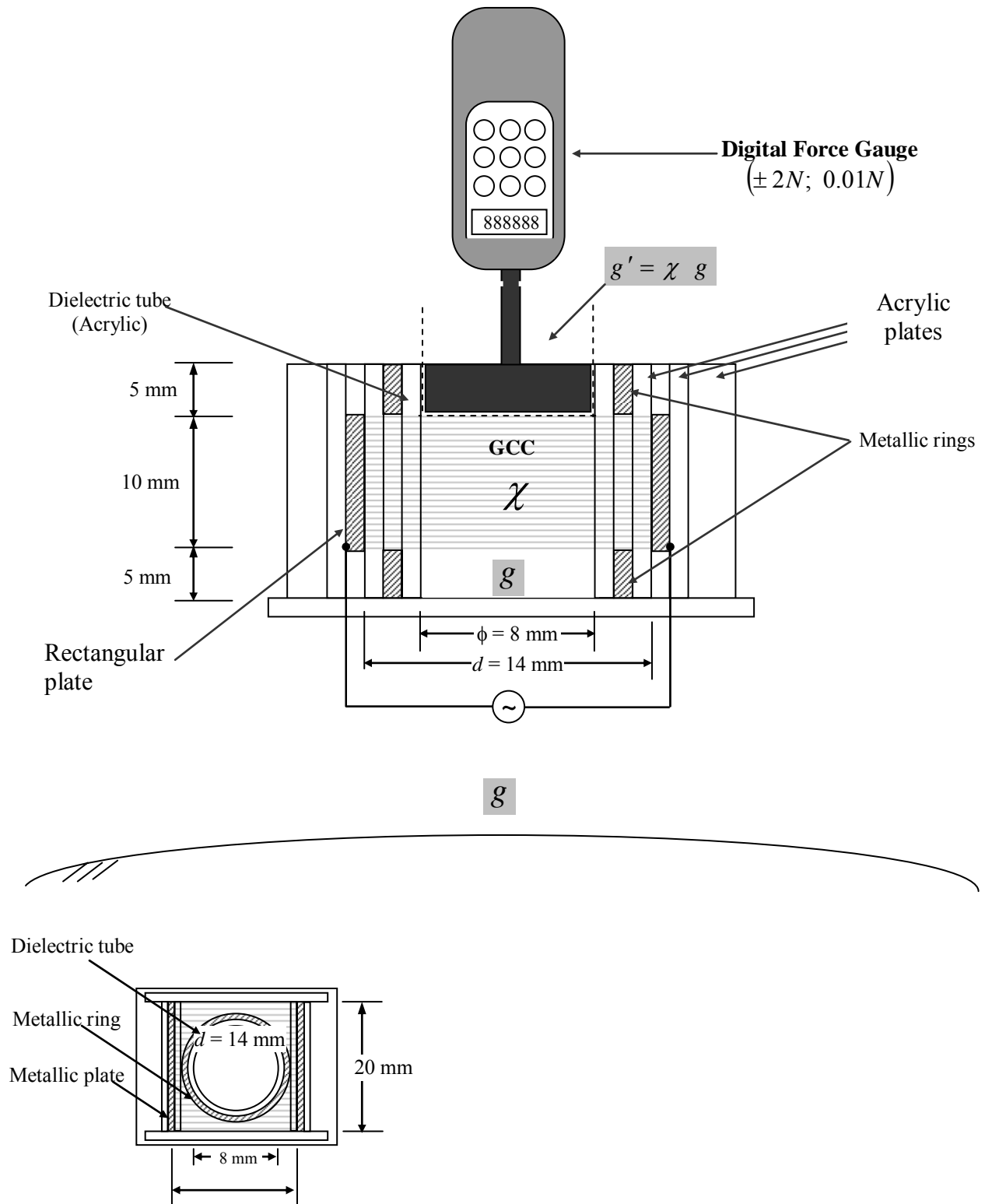

DETAILS OF PARTS

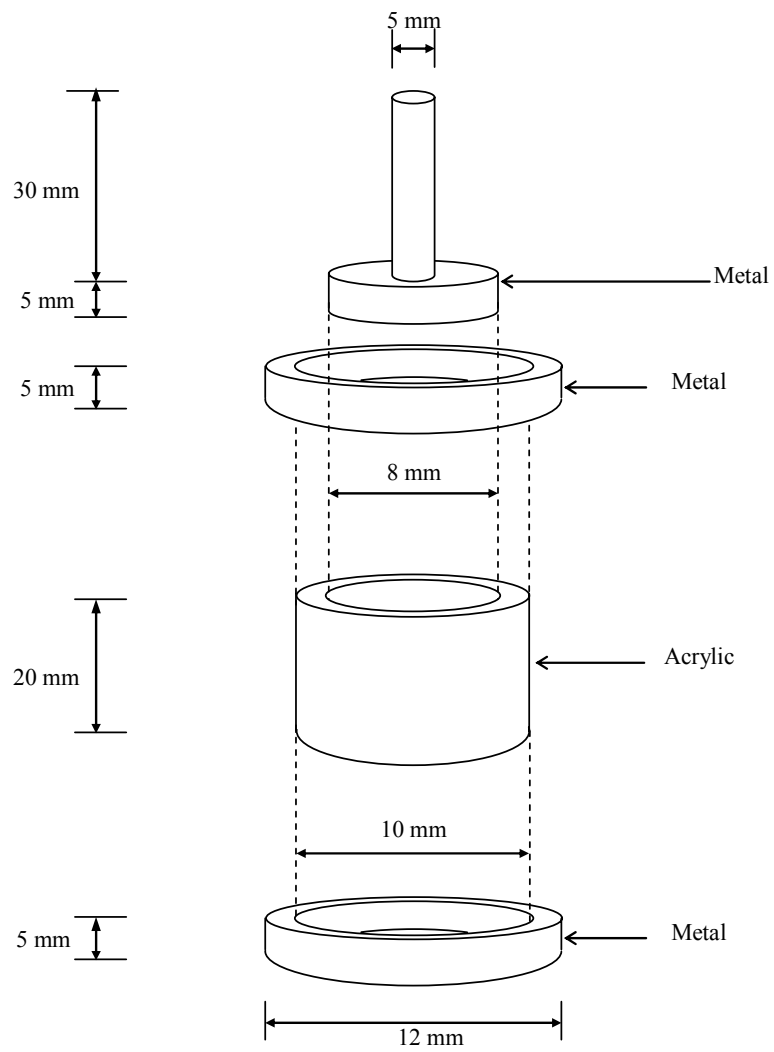

References

- [1] De Aquino, F. (2010) *Mathematical Foundations of the Relativistic Theory of Quantum Gravity*, Pacific Journal of Science and Technology, **11** (1), pp. 173-232.
- [2] Valkenburg, V., (1992) *Basic Electricity*, Prompt Publications, 1-38.
- [3] Fischer-Cripps, A., (2004) *The electronics companion*. CRC Press, p. 13, ISBN 9780750310123.
- [4] De Aquino, F. (2008) *Process and Device for Controlling the Locally the Gravitational Mass and the Gravity Acceleration*, BR Patent Number: PI0805046-5, July 31, 2008.
- [5] De Aquino, F. (2010) *Gravity Control by means of Electromagnetic Field through Gas at Ultra-Low Pressure*, Pacific Journal of Science and Technology, **11**(2) November 2010, pp.178-247, Physics/0701091.
- [6] Quevedo, C. P. (1977) *Eletromagnetismo*, McGraw-Hill, p. 270.
- [7] Halliday, D. and Resnick, R. (1968) *Physics*, J. Willey & Sons, Portuguese Version, Ed. USP, p.1124.
- [8] Chalmers, J.A., (1967) *Atmospheric Electricity*, Pergamon press, Oxford, London; Kamsali, N. et al., (2011) *Advanced Air Pollution*, chapter 20, DOI: 10.5772/17163, edited by Farhad Nejadkoorki, Publisher: InTech, ISBN 978-953-307-511-2, under CC BY-NC-SA 3.0 license.
- [9] Kundu, J. et al., (2007) *Semiconductor Physics, Quantum Electronics & Optoelectronics*, **10**, 1, pp.1-3.
- [10] Alonso, M. and Finn, E. (1967) *Fundamental University Physics*, Addison-Wesley Co., Portuguese version Ed Edgard Blücher (1972), p. 153.
- [11] Marshall, S. V. and Skitec, G.G. (1980) *Electromagnetic Concepts and Applications*, Prentice-Hall, NJ, Second Edition, p.287
- [12] Chen, D. et al., (1991) *Demagnetizing Factors for Cylinders*, IEE Transactions on Magnetics, Vol. 27, Number,4, p. 3601. Table V, p. 3610.
- [13] Mac Gregor. M. H., (1992) *The Enigmatic Electron*. Boston: Klurer Academic, 1992, pp. 4-5.
- [14] N.D. Cook (2010). *Models of the Atomic Nucleus* (2nd ed.). Springer. p. 57 ff.. ISBN 978-3-642-14736-4.
- [15] K.S. Krane (1987). *Introductory Nuclear Physics*. Wiley-VCH. ISBN 0-471-80553-X.